

KO4700 Series

66 Terminal Pluggable Connection



TECHNICAL INFORMATION

Electrical:
10A, 300V, 22-12 AWG

Housing Material:
Glass-filled Polycarbonate

Cover Material:
Glass-filled Polycarbonate

Temperature Range:
Up to 125°C (257°F)

Flammability Rating:
UL94 V-O (V-2 Clear Panel)

Color:
Black Housing with Tan Cover

Terminal Type:
Box Clamp

Terminal Screw Size:
M3.5

Recommended Torque:
0.8Nm

Max. PCB's:
(5) Vertical
(1) Behind cover

Mounting:
35mm DIN Rail or
optional panel mounting*

ORDERING INFORMATION

Part Number	Type	Description	PCB Connection
90.680	KO4721P	Solid Cover	Card Edge
90.681	KO4721P	Removable Cover Panel, Tan	Card Edge
90.682	KO4721P	Removable Cover Panel, Clear	Card Edge

ACCESSORIES

Accessories	Part Number	Type
1 Meter DIN Rail	2511120/1M	TS35x7.5/1M
*Panel Mount Tab (need 3)	93.001.2	PMA

ENCLOSURE DRAWING (To convert to inches divide by 25.4.)

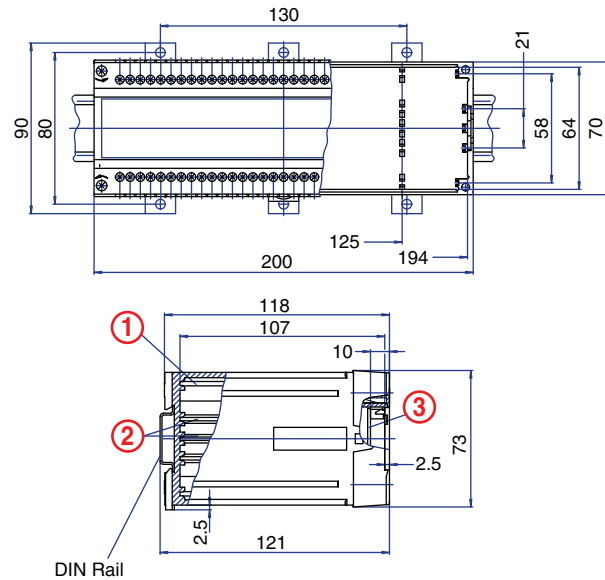

PCB DRAWING (To convert to inches divide by 25.4.)

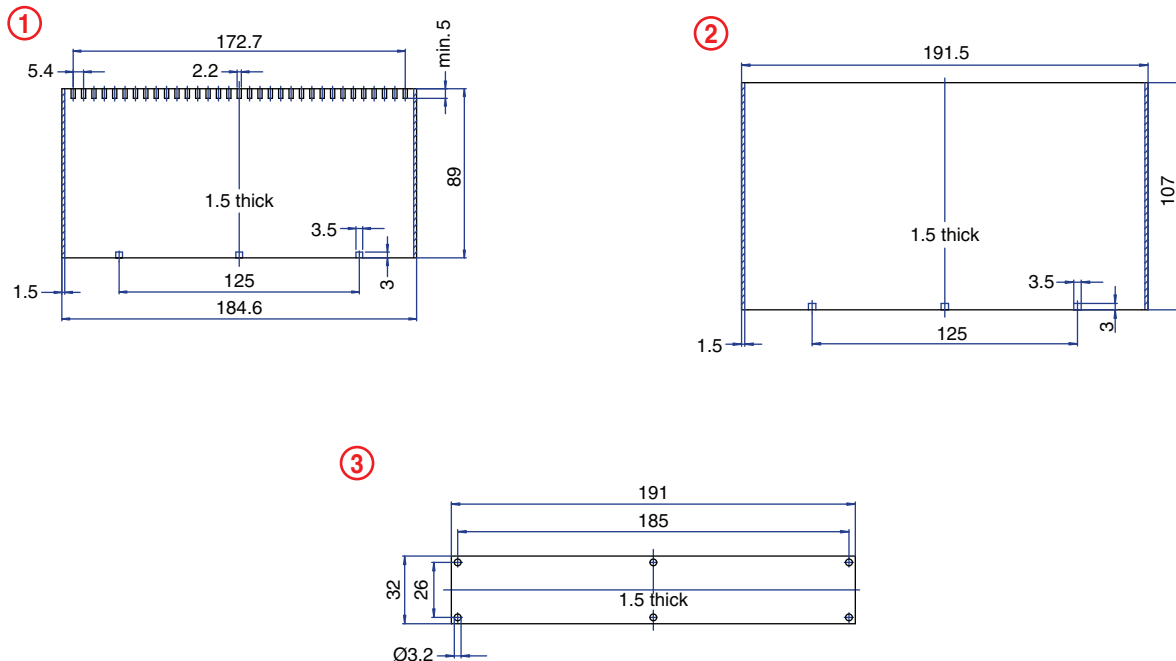

▨ unused space